

Modelica Language Concepts and Textual Modeling

Classes and Inheritance

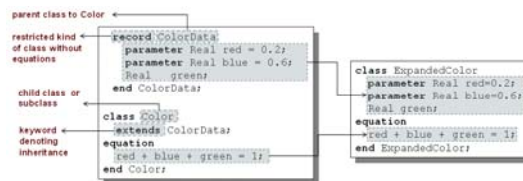

Typed
Declarative
Equation-based
Textual Language

Hybrid
Modeling

Acausal Modeling

The order of computations is not decided at modeling time

	Acausal	Causal
Visual Component Level		
Equation Level	<p>A resistor equation: $R \cdot i = v;$</p>	<p>Causal possibilities: $i := v/R;$ $v := R \cdot i;$ $R := v/i;$</p>

Typical Simulation Process

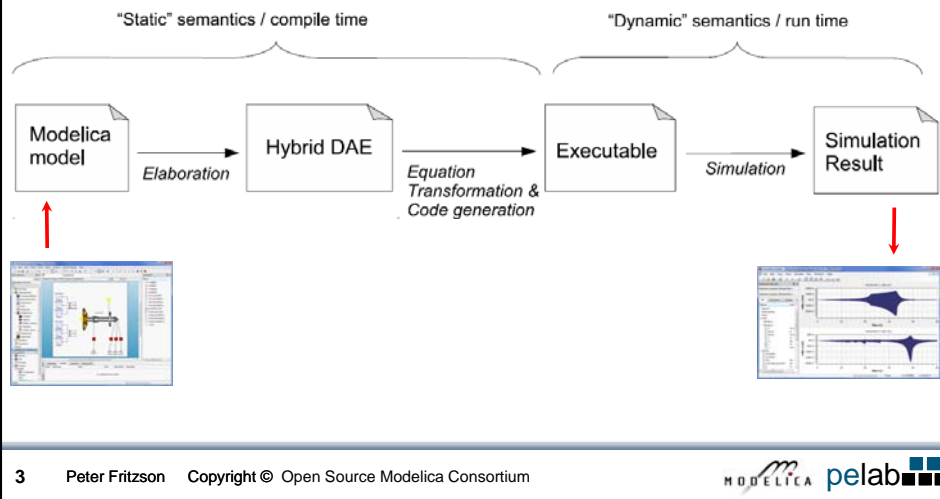

What is Special about Modelica?

- Multi-Domain Modeling
- Visual acausal hierarchical component modeling
- Typed declarative equation-based textual language
- Hybrid modeling and simulation

What is Special about Modelica?

Multi-Domain Modeling

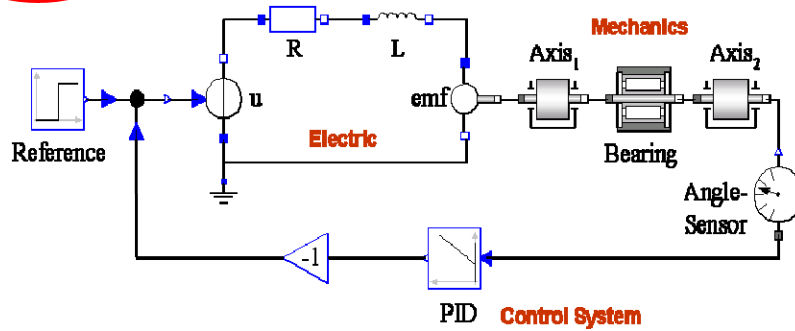

What is Special about Modelica?

Multi-Domain Modeling

Visual Acausal Hierarchical Component Modeling

Acausal model (Modelica)

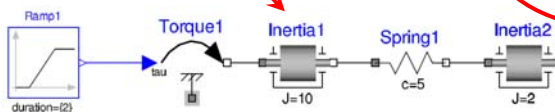

Causal block-based model (Simulink)

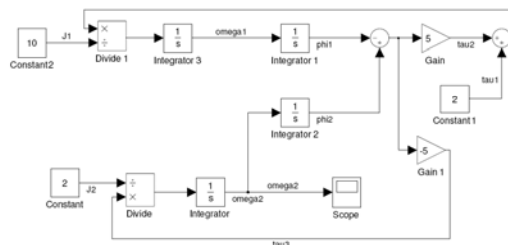

Keeps the physical structure

What is Special about Modelica?

Multi-Domain Modeling

Hierarchical system modeling

Visual Acausal Hierarchical Component Modeling

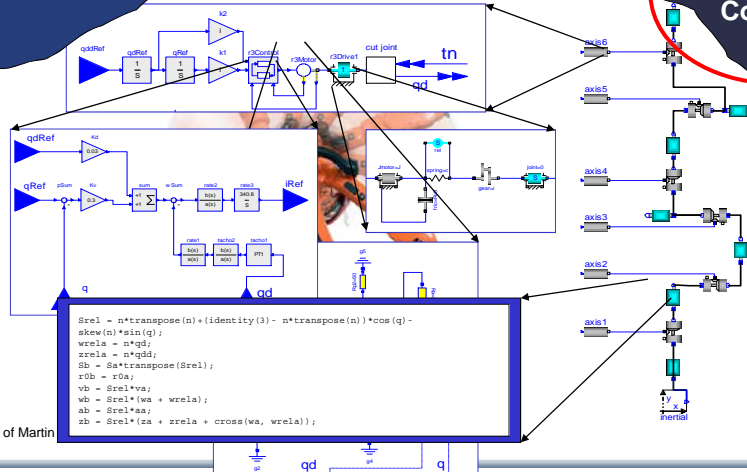

Courtesy of Martin

Copyright © Open Source Modelica Consortium

MODELICA pelab

What is Special about Modelica?

Multi-Domain Modeling

A textual *class-based* language
OO primary used for as a structuring concept

Visual Acausal Hierarchical Component Modeling

Behaviour described declaratively using

- Differential algebraic equations (DAE) (continuous-time)
- Event triggers (discrete-time)

Variable declarations

Typed Declarative Equation-based Textual Language

```
class VanDerPol "Van der Pol oscillator model"
  Real x(start = 1) "Descriptive string for x";
  Real y(start = 1) "y coordinate";
  parameter Real lambda = 0.3;
  equation
    der(x) = y;
    der(y) = -x + lambda*(1 - x*x)*y;
end VanDerPol;
```

Differential equations

8 Peter Fritzon Copyright © Open Source Modelica Consortium

MODELICA pelab

What is Special about Modelica?

Multi-Domain
Modeling

Visual Acausal
Component
Modeling

Hybrid modeling =
continuous-time + discrete-time modeling

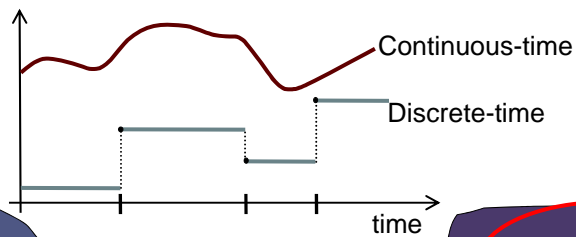

Typed
Declarative
Equation-based
Textual Language

Hybrid
Modeling

Modelica Classes and Inheritance

Simplest Model – Hello World!

A Modelica “Hello World” model

Equation: $x' = -x$
Initial condition: $x(0) = 1$

```
class HelloWorld "A simple equation"  
  Real x(start=1);  
equation  
  der(x) = -x;  
end HelloWorld;
```

Simulation in OpenModelica environment

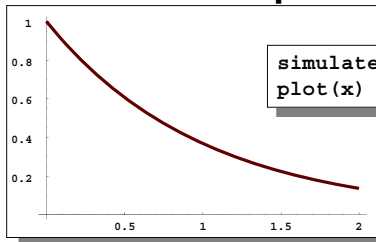

```
simulate(HelloWorld, stopTime = 2)  
plot(x)
```

Model Including Algebraic Equations

Include algebraic equation

Algebraic equations contain
no derivatives

```
class DAEexample  
  Real x(start=0.9);  
  Real y;  
equation  
  der(y) + (1 + 0.5 * sin(y)) * der(x)  
    = sin(time);  
  x - y = exp(-0.9 * x) * cos(y);  
end DAEexample;
```

Simulation in OpenModelica environment

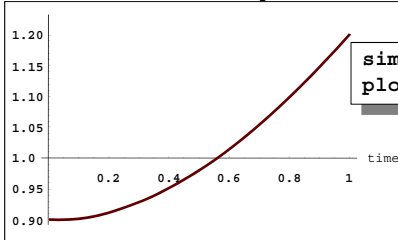

```
simulate(DAEexample, stopTime = 1)  
plot(x)
```

Example class: Van der Pol Oscillator

```
class VanDerPol "Van der Pol oscillator model"  
  Real x(start = 1) "Descriptive string for x"; // x starts at 1  
  Real y(start = 1) "y coordinate";           // y starts at 1  
  parameter Real lambda = 0.3;  
equation  
  der(x) = y; // This is the 1st diff equation //  
  der(y) = -x + lambda*(1 - x*x)*y; /* This is the 2nd diff equation */  
end VanDerPol;
```

```
simulate(VanDerPol, stopTime = 25)  
plotParametric(x, y)
```

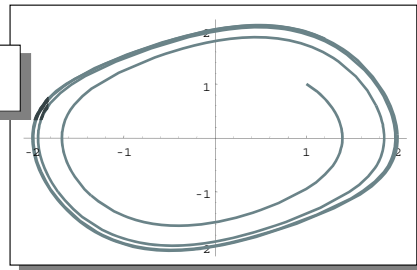

Exercises – Simple Textual Modeling

- Start OMNotebook
 - Start->Programs->OpenModelica->OMNotebook
 - Open File: Exercise01-classes-simple-textual.onb
- Open Exercise01-classes-simple-textual.pdf

Exercises 2.1 and 2.2

- Open the **Exercise01-classes-simple-textual.onb** found in the Tutorial directory.
- Locate the VanDerPol model in DrModelica (link from Section 2.1), using OMNotebook!
- **Exercise 2.1:** Simulate and plot VanDerPol. Do a slight change in the model, re-simulate and re-plot.
- **Exercise 2.2.** Simulate and plot the HelloWorld example. Do a slight change in the model, re-simulate and re-plot. Try command-completion, `val()`, etc.

```
class HelloWorld "A simple equation"
  Real x(start=1);
equation
  der(x) = -x;
end HelloWorld;

simulate(HelloWorld, stopTime = 2)
plot(x)
```

Variables and Constants

Built-in primitive data types

- Boolean** true or false
- Integer** Integer value, e.g. 42 or -3
- Real** Floating point value, e.g. 2.4e-6
- String** String, e.g. "Hello world"
- Enumeration** Enumeration literal e.g. `ShirtSize.Medium`

Variables and Constants cont'

- Names indicate meaning of constant
- Easier to maintain code
- Parameters are constant during simulation
- Two types of constants in Modelica
 - `constant`
 - `parameter`

```
constant Real    PI=3.141592653589793;  
constant String  redcolor = "red";  
constant Integer one = 1;  
parameter Real   mass = 22.5;
```

Comments in Modelica

- 1) Declaration comments, e.g. `Real x "state variable";`

```
class VanDerPol "Van der Pol oscillator model"  
  Real x(start = 1) "Descriptive string for x"; // x starts at 1  
  Real y(start = 1) "y coordinate";           // y starts at 1  
  parameter Real lambda = 0.3;  
equation  
  der(x) = y; // This is the 1st diff equation //  
  der(y) = -x + lambda*(1 - x*x)*y; /* This is the 2nd diff equation */  
end VanDerPol;
```

- 2) Source code comments, disregarded by compiler
 - 2a) C style, e.g. `/* This is a C style comment */`
 - 2b) C++ style, e.g. `// Comment to the end of the line...`

A Simple Rocket Model

Rocket

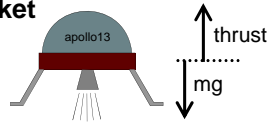

$$acceleration = \frac{thrust - mass \cdot gravity}{mass}$$

$$mass' = -massLossRate \cdot abs(thrust)$$

$$altitude' = velocity$$

$$velocity' = acceleration$$

```

class Rocket, "rocket class"
  parameter String name;
  Real mass(start=1038.358);
  Real altitude(start= 59404);
  Real velocity(start=-2003);
  Real acceleration;
  Real thrust; // Thrust force on rocket
  Real gravity; // Gravity forcefield
  parameter Real massLossRate=0.000277;
equation
  ((thrust-mass*gravity)/mass) = acceleration;
  der(mass) = -massLossRate * abs(thrust);
  der(altitude) = velocity;
  der(velocity) = acceleration;
end Rocket;
  
```

new model ←

parameters (changeable before the simulation) ←

floating point type ←

differentiation with regards to time ←

→ declaration comment

→ start value

→ name + default value

→ mathematical equation (acausal)

Celestial Body Class

A class declaration creates a *type name* in Modelica

```

class CelestialBody
  constant Real g = 6.672e-11;
  parameter Real radius;
  parameter String name;
  parameter Real mass;
end CelestialBody;
  
```



An *instance* of the class can be declared by *prefixing* the type name to a variable name

```

...
CelestialBody moon;
...
  
```

The declaration states that `moon` is a variable containing an object of type `CelestialBody`

Moon Landing

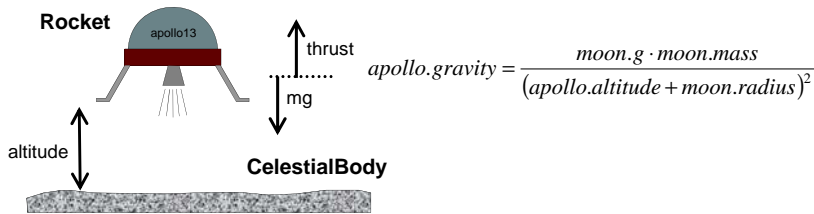

only access
inside the class

access by dot
notation outside
the class

```
class MoonLanding
  parameter Real force1 = 36350;
  parameter Real force2 = 1308;
  protected
  parameter Real thrustEndTime = 210;
  parameter Real thrustDecreaseTime = 43.2;
  public
  Rocket apollo(name="apollo13");
  CelestialBody moon(name="moon",mass=7.382e22,radius=1.738e6);
  equation
  apollo.thrust = if (time < thrustDecreaseTime) then force1
    else if (time < thrustEndTime) then force2
    else 0;
  apollo.gravity=moon.g*moon.mass/(apollo.altitude+moon.radius)^2;
end MoonLanding;
```

Simulation of Moon Landing

```
simulate(MoonLanding, stopTime=230)
plot(apollo.altitude, xrange={0,208})
plot(apollo.velocity, xrange={0,208})
```

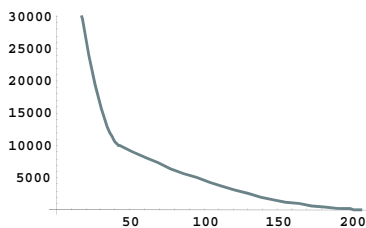

It starts at an altitude of 59404 (not shown in the diagram) at time zero, gradually reducing it until touchdown at the lunar surface when the altitude is zero

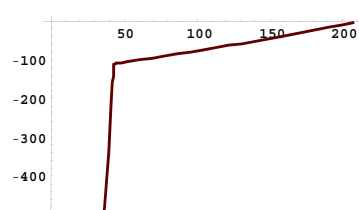

The rocket initially has a high negative velocity when approaching the lunar surface. This is reduced to zero at touchdown, giving a smooth landing

Restricted Class Keywords

- The `class` keyword can be replaced by other keywords, e.g.: `model`, `record`, `block`, `connector`, `function`, ...
- Classes declared with such keywords have restrictions
- Restrictions apply to the contents of restricted classes
- Example: A `model` is a class that cannot be used as a connector class
- Example: A `record` is a class that only contains data, with no equations
- Example: A `block` is a class with fixed input-output causality

```
model CelestialBody
  constant Real    g = 6.672e-11;
  parameter Real   radius;
  parameter String name;
  parameter Real   mass;
end CelestialBody;
```

Modelica Functions

- Modelica Functions can be viewed as a special kind of restricted class with some extensions
- A function can be called with arguments, and is instantiated dynamically when called
- More on functions and algorithms later in Lecture 4

```
function sum
  input Real arg1;
  input Real arg2;
  output Real result;
algorithm
  result := arg1+arg2;
end sum;
```

Inheritance

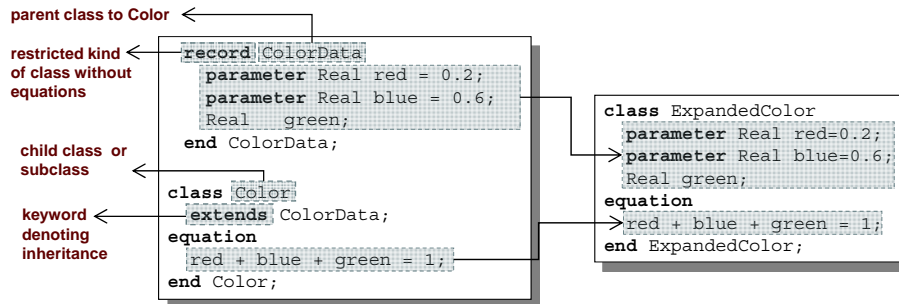

Data and behavior: field declarations, equations, and certain other contents are copied into the subclass

Inheriting definitions

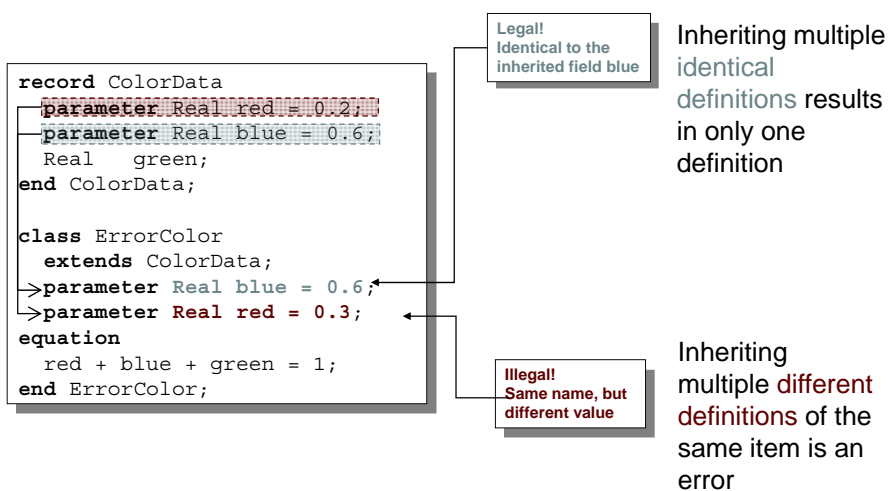

Inheritance of Equations

```
class Color
  parameter Real red=0.2;
  parameter Real blue=0.6;
  Real green;
  equation
    red + blue + green = 1;
end Color;
```

```
class Color2 // OK!
  extends Color;
  equation
    red + blue + green = 1;
end Color2;
```

```
class Color3 // Error!
  extends Color;
  equation
    red + blue + green = 1.0;
    // also inherited: red + blue + green = 1;
end Color3;
```

Color is identical to Color2
 → Same equation twice leaves one copy when inheriting

Color3 is overdetermined
 → Different equations means two equations!

Multiple Inheritance

Multiple Inheritance is fine – inheriting both geometry and color

```
class Color
  parameter Real red=0.2;
  parameter Real blue=0.6;
  Real green;
  equation
    red + blue + green = 1;
end Color;
```

```
class Point
  Real x;
  Real y, z;
end Point;
```

```
class ColoredPoint
  extends Point;
  extends Color;
end ColoredPoint;
```

multiple inheritance

```
class ColoredPointWithoutInheritance
  Real x;
  Real y, z;
  parameter Real red = 0.2;
  parameter Real blue = 0.6;
  Real green;
  equation
    red + blue + green = 1;
end ColoredPointWithoutInheritance;
```

Equivalent to

Multiple Inheritance cont'

Only one copy of multiply inherited class Point is kept

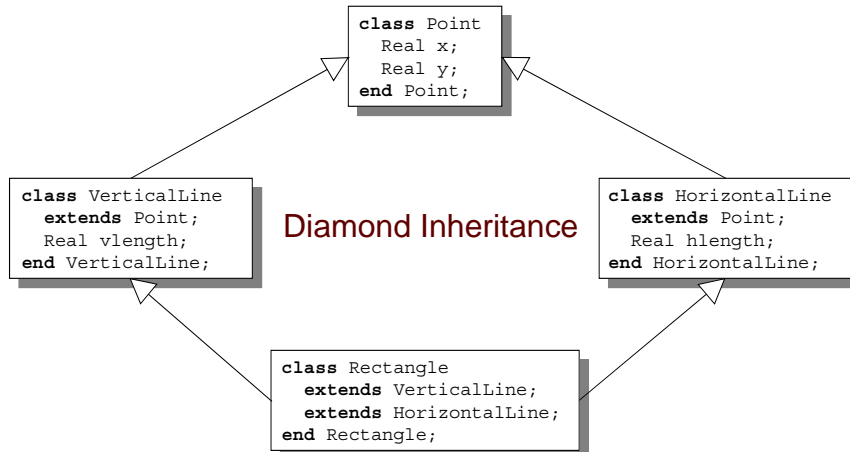

Simple Class Definition – Shorthand Case of Inheritance

- Example:

```
class SameColor = Color;
```

Equivalent to:

```
class SameColor
  extends Color;
end SameColor;
```

inheritance ←

- Often used for introducing new names of types:

```
type Resistor = Real;
```

```
connector MyPin = Pin;
```

Inheritance Through Modification

- Modification is a concise way of combining inheritance with declaration of classes or instances
- A modifier modifies a declaration equation in the inherited class
- Example: The class `Real` is inherited, modified with a different `start` value equation, and instantiated as an `altitude` variable:

```
...
Real altitude(start= 59404);
...
```

The Moon Landing Example Using Inheritance

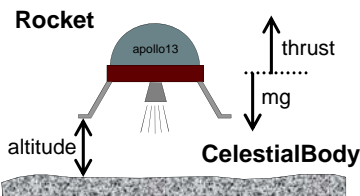

```
model Body "generic body"
  Real mass;
  String name;
end Body;
```

```
model CelestialBody
  extends Body;
  constant Real g = 6.672e-11;
  parameter Real radius;
end CelestialBody;
```

```
model Rocket "generic rocket class"
  extends Body;
  parameter Real massLossRate=0.000277;
  Real altitude(start= 59404);
  Real velocity(start= -2003);
  Real acceleration;
  Real thrust;
  Real gravity;
equation
  thrust-mass*gravity= mass*acceleration;
  der(mass)= -massLossRate*abs(thrust);
  der(altitude)= velocity;
  der(velocity)= acceleration;
end Rocket;
```

The Moon Landing Example using Inheritance cont'

```

model MoonLanding
  parameter Real force1 = 36350;
  parameter Real force2 = 1308;
  parameter Real thrustEndTime = 210;
  parameter Real thrustDecreaseTime = 43.2;
  Rocket apollo (name="apollo13", mass(start=1038.358) );
  CelestialBody moon (mass=7.382e22, radius=1.738e6, name="moon" );
  equation
    apollo.thrust = if (time<thrustDecreaseTime) then force1
                    else if (time<thrustEndTime) then force2
                    else 0;
    apollo.gravity = moon.g*moon.mass/(apollo.altitude+moon.radius)^2;
  end Landing;

```

Inheritance of Protected Elements

If an extends-clause is preceded by the `protected` keyword, all inherited elements from the superclass become protected elements of the subclass

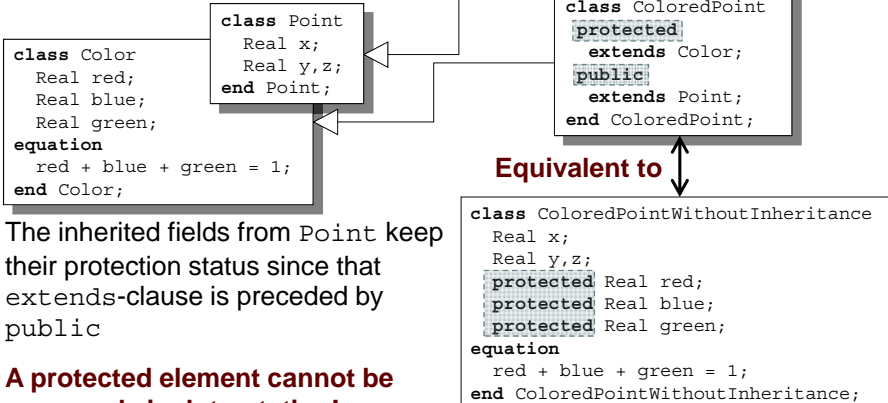

Advanced Topic

- Class parameterization

Generic Classes with Type Parameters

Formal class parameters are replaceable variable or type declarations within the class (usually marked with the prefix `replaceable`)

Actual arguments to classes are modifiers, which when containing whole variable declarations or types are preceded by the prefix `redeclare`

```
class C
  replaceable class ColoredClass = GreenClass;
  ColoredClass obj1 (p1=5);
  replaceable YellowClass obj2;
  ColoredClass obj3;
  RedClass obj4;
equation
end C;
```

```
class C2 =
  C(redeclare class ColoredClass = BlueClass);
```

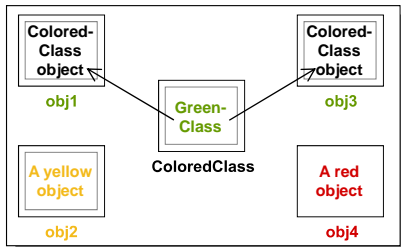

Equivalent to

```
class C2
  BlueClass obj1 (p1=5);
  YellowClass obj2;
  BlueClass obj3;
  RedClass obj4;
equation
end C2;
```

Class Parameterization when Class Parameters are Components

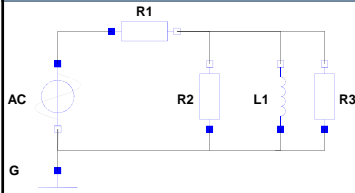

The class `ElectricalCircuit` has been converted into a parameterized generic class `GenericElectricalCircuit` with three formal class parameters `R1`, `R2`, `R3`, marked by the keyword `replaceable`

```
class ElectricalCircuit
  Resistor R1(R=100);
  Resistor R2(R=200);
  Resistor R3(R=300);
  Inductor L1;
  SineVoltage AC;
  Ground G;
equation
  connect(R1.n,R2.n);
  connect(R1.n,L1.n);
  connect(R1.n,R3.n);
  connect(R1.p,AC.p);
  .....
end ElectricalCircuit;
```

Class parameterization

```
class GenericElectricalCircuit
  replaceable Resistor R1(R=100);
  replaceable Resistor R2(R=200);
  replaceable Resistor R3(R=300);
  Inductor L1;
  SineVoltage AC;
  Ground G;
equation
  connect(R1.n,R2.n);
  connect(R1.n,L1.n);
  connect(R1.n,R3.n);
  connect(R1.p,AC.p);
  .....
end GenericElectricalCircuit;
```

Class Parameterization when Class Parameters are Components - cont'

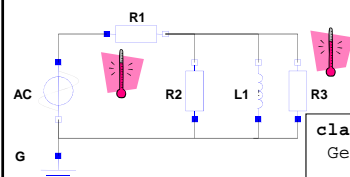

A more specialized class `TemperatureElectricalCircuit` is created by changing the types of `R1`, `R3`, to `TempResistor`

```
class TemperatureElectricalCircuit =
  GenericElectricalCircuit
  redeclare TempResistor R1;
  redeclare TempResistor R3;
```

```
class TemperatureElectricalCircuit
  parameter Real Temp=20;
  extends GenericElectricalCircuit(
    redeclare TempResistor R1(RT=0.1, Temp=Temp),
    redeclare TempResistor R3(R=300));
end TemperatureElectricalCircuit
```

We add a temperature variable `Temp` for the temperature of the resistor circuit and modifiers for `R1` and `R3` which are now `TempResistors`.

equivalent to

```
class ExpandedTemperatureElectricalCircuit
  parameter Real Temp;
  TempResistor R1(R=200, RT=0.1, Temp=Temp),
  replaceable Resistor R2;
  TempResistor R3(R=300);
equation
  ....
end ExpandedTemperatureElectricalCircuit
```

Exercises 1 Simple Textual Continued

- Continue exercises in Exercise01-classes-simple-textual.onb
- Do Exercises 1.3, 1.4, 1.5 and 2

Exercise 1.3 – Model the System Below

- Model this Simple System of Equations in Modelica

$$\dot{x} = 2 * x * y - 3 * x$$

$$\dot{y} = 5 * y - 7 * x * y$$

$$x(0) = 2$$

$$y(0) = 3$$